

Sistema V-Lock
The V-Lock system



CE

573

METAL LOCK

SVAK



O sistema V-Lock inclui vários componentes de automação e elementos de fixação.

The V-Lock system is a range of components for automation and fixing elements.

V-Lock com sistema de conexão modular de montagem fácil, rápida configuração e conexões precisas ou posição de montagem ajustável opcional. Este sistema modular universal e padronizado facilita o trabalho do projetista, pois não é necessário projetar adaptadores, flanges, suportes e assim por diante, permitindo que o mesmo dedique seu tempo, apenas ao projeto da máquina. Da mesma forma, a pessoa que monta os componentes, conta com um kit completo, fácil e rápido de usar, o qual permite montar, configurar e reconfigurar a máquina em pouco tempo.

V-Lock featuring a standard modular connecting system, easy assembly, rapid configuration, and the option of either precise repeatable connections or an adjustable mounting position. This standard and universal modular system makes the designer's work easier because it is not necessary to design adaptors, flanges, brackets and so on, and he can concentrate on the heart of the problem, namely the design of the machine. Likewise, the person who assembles the components is provided with a complete kit that is quick and easy to use, so the machine can be assembled, set up and reconfigured in a very short time.

Elementos básicos

Basic elements



Elementos de fixação V-Lock
V-Lock fixing elements



Adaptadores V-Lock
V-Lock adaptors



Perfis
Profiles

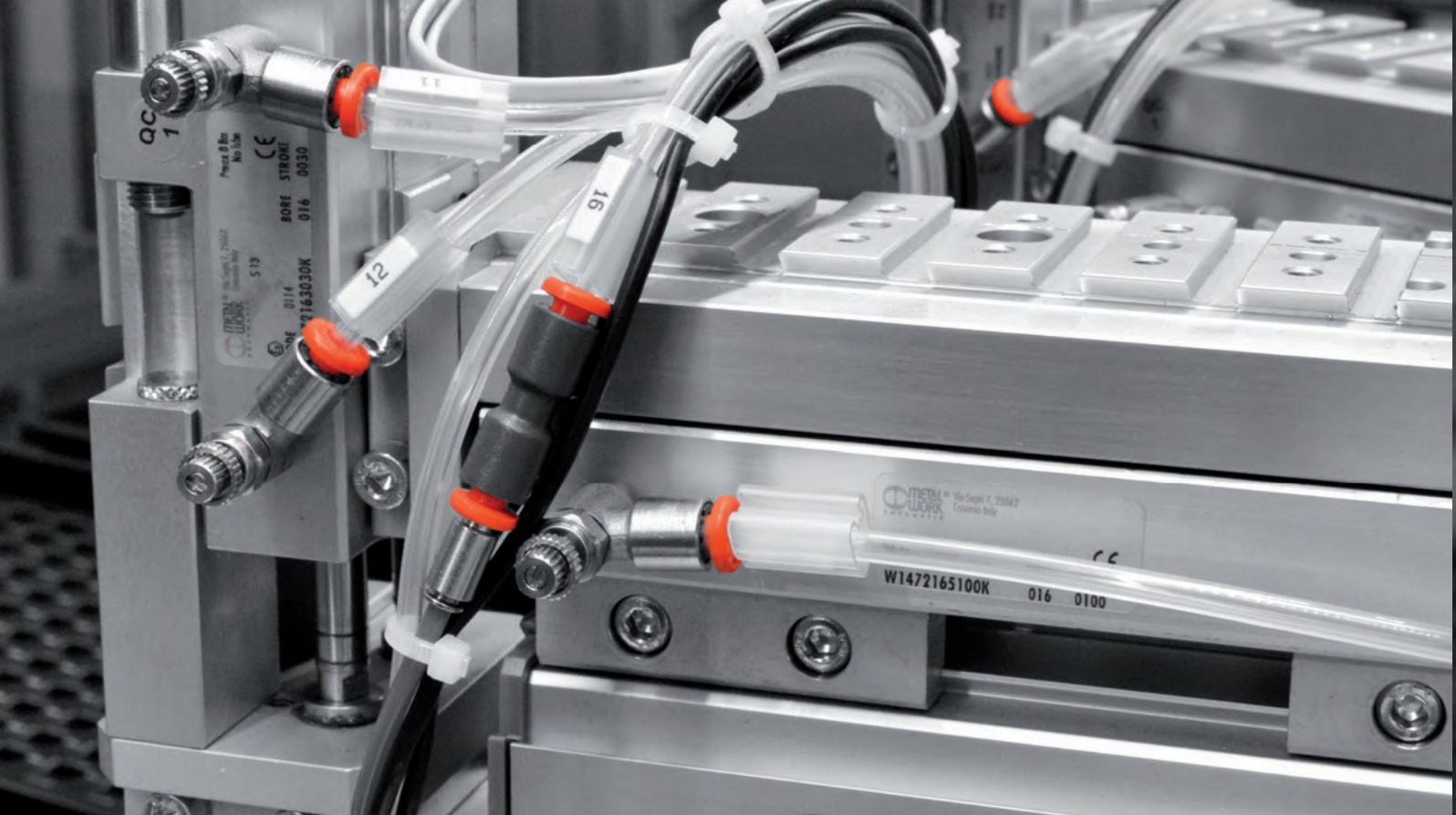

Atuadores lineares Linear actuators



Cilindro sem haste com
guia de recirculantes esferas
Série V-Lock
*Rodless cylinder with ball
recirculating guide Series V-Lock*

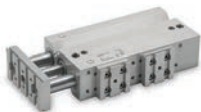

Cilindro compacto guiado
Série CMPGK
*Compact guided cylinder
Series CMPGK*



Unidade linear Série LEPK
Linear units Series LEPK



Guia linear de precisão
compacta S14K
*Compact precision slide
Series S14K*

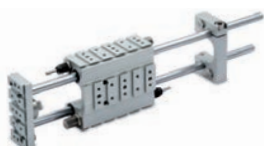

Unidade de guia Série
GDHK e GDMK
*Guide units Series GDHK
and GDMK*

Atuadores rotativos Rotary actuators



Atuador rotativo Série R3K
Rotary actuator Series R3K



Atuador rotativo Série DAPK
Rotary actuator Series DAPK



Atuador rotativo Série R3K
com amortecedores externos
*Rotary actuator Series R3K
with external shock absorbers*

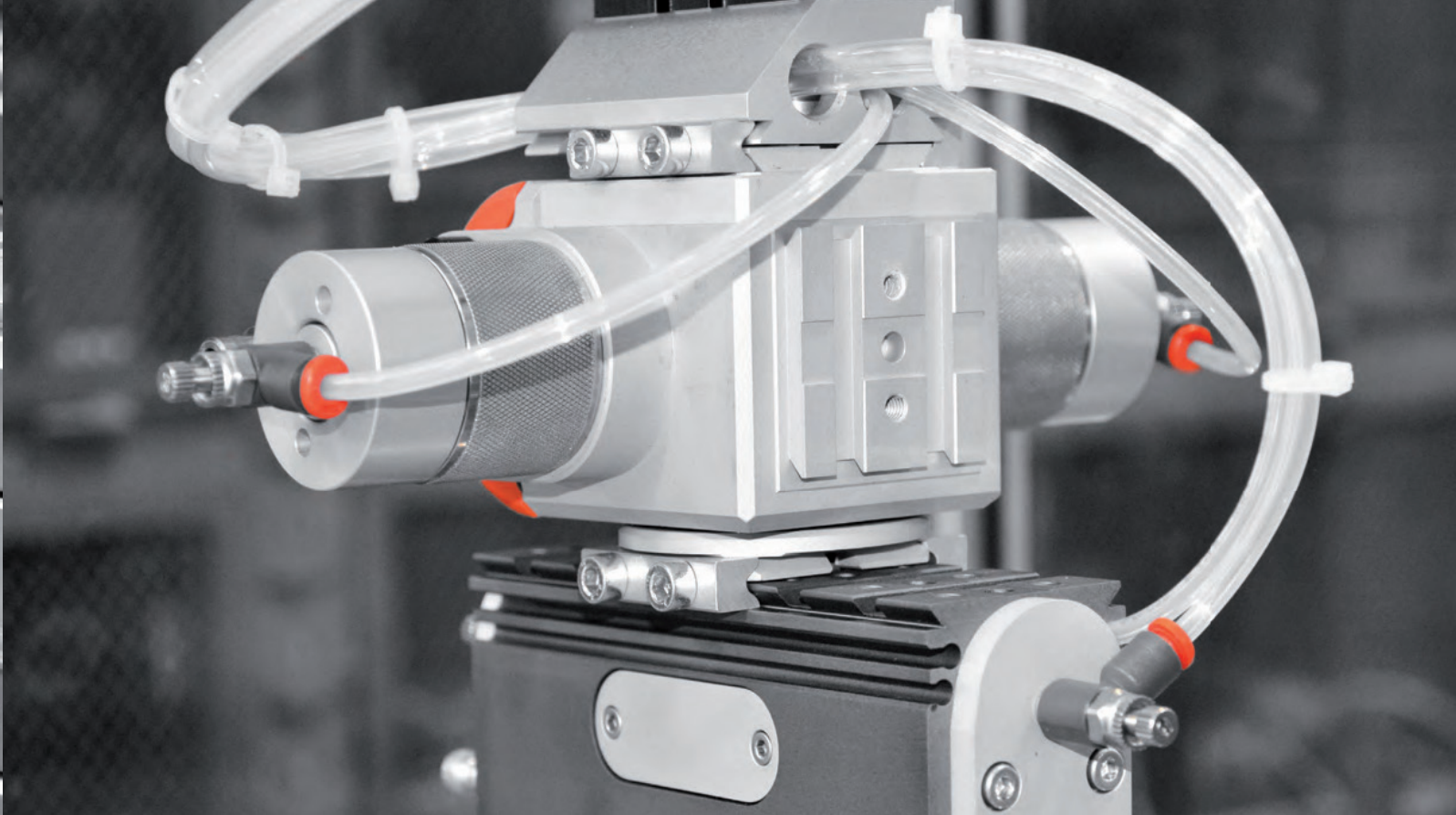

Sistema de eixo elétrico

Electric axis system



Eixo elétrico elektro
Série SHAK
*Electric axis elektro
SHAK Series*



Eixo elétrico – sem haste
Elektro Séries BK
*Electric axis - rodless
elektro Series BK*



Eixo elétrico Série elektro
Cantilever VBK
*Cantilever electric axis
elektro Series VBK*



Eixo elétrico Série elektro
SHAK GANTRY
*Electric axis Series elektro
SHAK GANTRY*



Eixo elétrico elektro
Série Cantilever SVAK
*Cantilever electric axis
elektro Series SVAK*

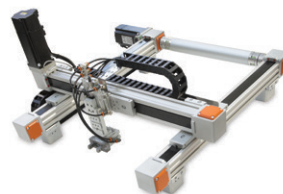

Eixo elétrico Série elektro
BK GANTRY
*Electric axis Series elektro
BK GANTRY*



Eixo elétrico – sem haste
elektro Série SK
*Electric axis - rodless
elektro Series SK*



Guia linear Série elektro
CS
*Electric slide Series elektro
CS*



Atuador rotativo
Série Elektro RBA
*Electric rotary actuator
Series elektro RBA*

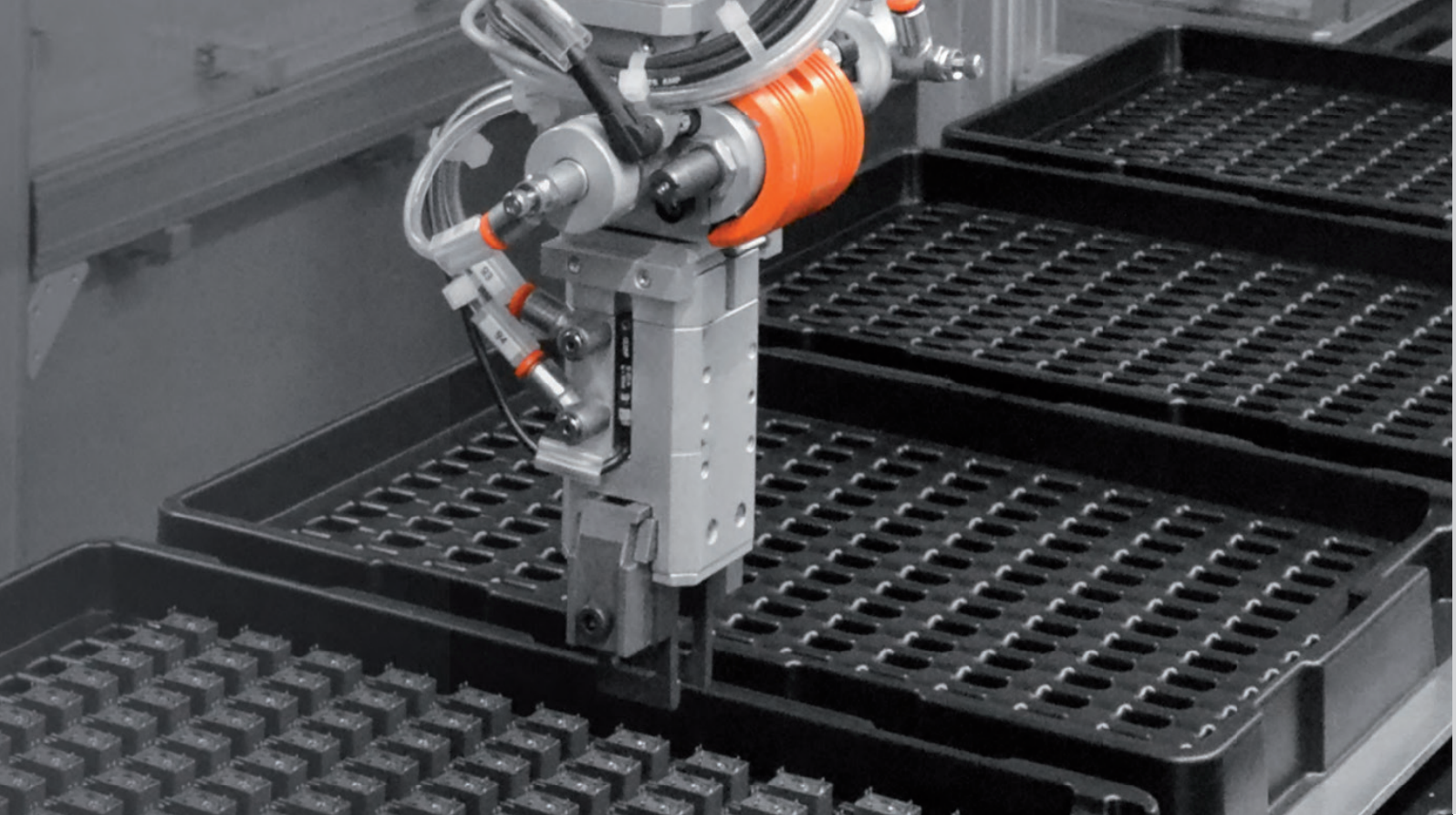

Pinças Grippers



Pinça com duas garras paralelas Série P1K
Gripper with two parallel jaws Series P1K



Pinça com duas garras paralelas Série P2K
Gripper with two parallel jaws Series P2K



Pinça com duas garras paralelas Série P3K
Gripper with two parallel jaws Series P3K



Pinça com duas garras paralelas, curso longo, Série P4K
Gripper with two parallel jaws, long stroke Series P4K



Pinça com duas garras paralelas, curso longo, Série GPLK
Gripper with two parallel jaws, long stroke Series GPLK



Pinça com duas garras paralelas Série P7K
Gripper with two hinged jaws Series P7K



Pinça 180° com duas garras articuladas Série P9K
Gripper 180° with two hinged jaws Series P9K



Pinça com três garras paralelas Série P12K
Gripper with three parallel jaws Series P12K

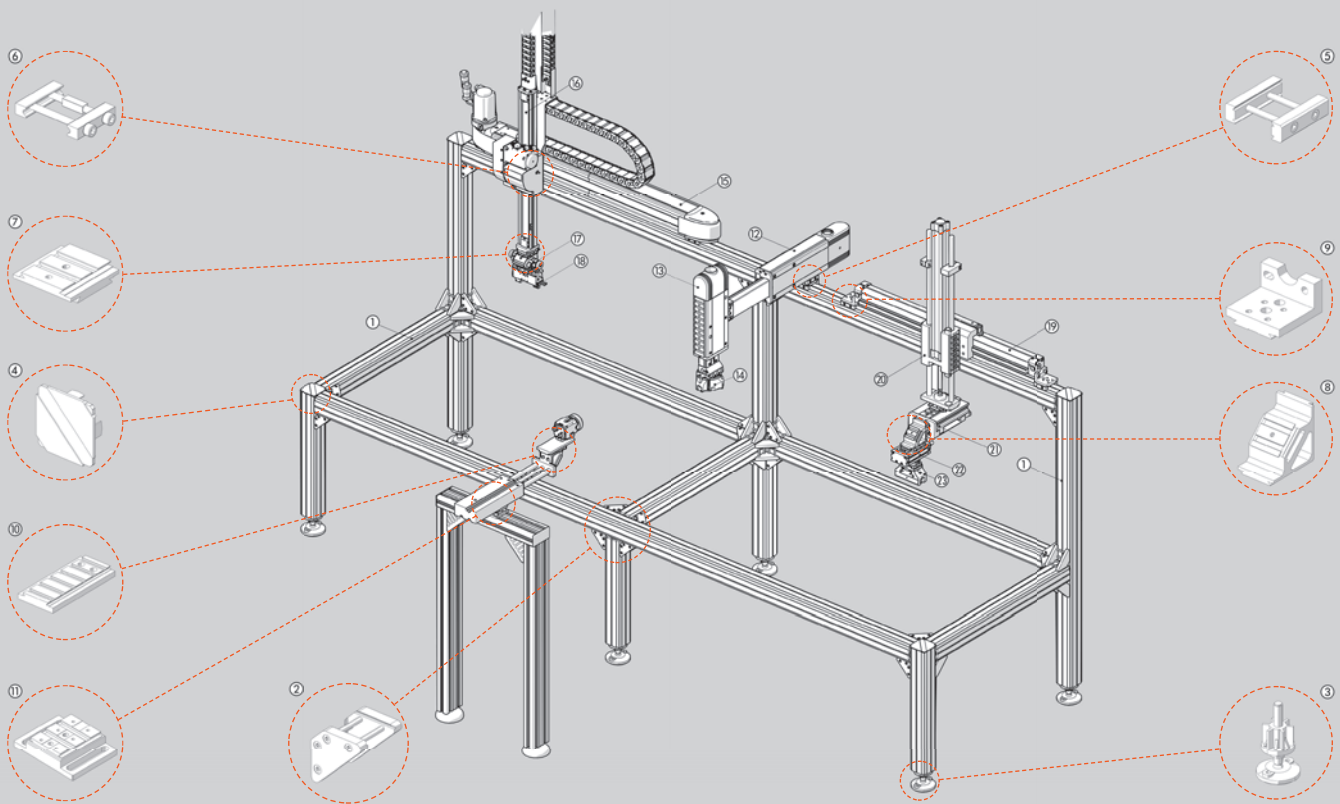

Guia

O sistema V-Lock pode ser usado para criar sistemas de automação pneumáticos e/ou elétricos para uma ampla gama de aplicações, da mais simples à mais complexa.

- 1 PERFIS de fixação com encaixe rápido, que podem ser cortados usando cortador padrão sem necessidade de usinagem específica. Não exige furos roscados ou orifícios. Os elementos de fixação com encaixe suportam cargas mais altas que ranhuras em T.
- 2 SUPORTES para perfis de fixação rápida.
- 3 PÉS articulados com ajuste de comprimento de 90 mm.
- 4 TAMPA de plástico para perfis.
- 5 ELEMENTOS DE FIXAÇÃO QS para acoplamento de perfis e/ou componentes V-Lock (não exige ranhuras transversais V-Lock).
- 6 ELEMENTOS DE FIXAÇÃO K para acoplamentos V-Lock, usando ranhuras transversais de componentes V-Lock. Oferecem alta precisão, repetibilidade e redução de espaço.
- 7 ADAPTADORES paralelos ou transversais para acoplamento de componentes V-Lock, por exemplo, rotacionados 90°.
- 8 SUPORTES para fixação com ângulo de 45° ou 90°, longitudinal, transversal ou cruzado.
- 9 Vários ACESSÓRIOS de fixação V-Lock: pés, flanges, etc.
- 10 TRANSFORMADORES V-Lock fixos, em qualquer componente (ex.: câmara de vídeo na foto), se converte em componente V-Lock.
- 11 ADAPTADORES DE PERFIL para fixar qualquer tipo de perfil (Bosch®, Item®, etc.) disponível no mercado em componentes V-Lock.
- 12 UNIDADE LINEAR SÉRIE LEPK controlada pneumáticamente, oferecendo alta precisão e rigidez, vida útil longa, cursos ajustáveis, batente final com amortecedor e 2 ou 3 posições.
- 13 UNIDADES LINEARES SÉRIE LEPK PARA MONTAGEM VERTICAL, contando com balanceamento de peso do deslizador e massa aplicada.
- 14 PINÇAS DE 3 GARRAS.
- 15 EIXOS ELÉTRICOS SÉRIE ELEKTRO com correia dentada e vários sistemas de guia e acionamento. A figura mostra um eixo elétrico no equipamento série Elektro SHAK 340.
- 16 EIXO ELÉTRICO PARA APLICAÇÕES VERTICAIS A figura mostra um eixo elétrico no equipamento série Elektro SVAK.
- 17 ATUADORES ROTATIVOS DE PRECISÃO controlados pneumáticamente. A figura mostra um atuador DAPK com 2 ângulos ajustáveis.
- 18 PINÇAS DE PRECISÃO. A figura mostra uma pinça dupla de curso longo paralela na série GPLK.
- 19 CILINDROS SEM HASTE com guia de circulação de esfera V-Lock.
- 20 UNIDADE DE GUIA V-Lock para cilindros pneumáticos ISO 15552 ou cilindros elétricos Elektro 15552.
- 21 DESLIZADORES. A figura mostra um deslizador de precisão compacto S14K.
- 22 ATUADORES ROTATIVOS pneumáticos R3K com ângulo ajustável, batente mecânico ou amortecedor hidráulico interno ou externo.
- 23 PINÇAS com duas garras paralelas, duas garras articuladas, junta de comutação e três garras.

Guide

The V-Lock system can be used to create pneumatic and/or electrical automation systems for a wide range of applications, from simple to more complex ones.

Quick-Set dovetail fixing PROFILES, which can be cut up using a standard die-cutter and do not require any particular machining; no threaded holes or pinholes are required. Dovetail fixing elements can withstand greater loads than those with T-grooves.

BRACKETS for fixing Quick-set profiles.

Articulated FEET with 90mm adjustment length.

Plastic CAP for profiles.

QS FIXING ELEMENTS for the coupling of V-Lock profiles and/or components (no need for V-Lock transverse grooves).

K FIXING ELEMENTS for V-Lock couplings, using the transverse grooves of V-Lock components. They feature high precision, repeatability and space saving.

Parallel or crosswise ADAPTORS for the coupling of V-Lock components, e.g. rotated by 90 degrees.

BRACKETS for fixing at a 45° or 90° angle, longitudinal, transversal, cross.

Various V-Lock fixing ACCESSORIES: feet, flanges, etc.

V-Lock TRANSFORMERS fixed to any component (a video camera in the photo) convert it into a V-Lock component.

PROFILE ADAPTORS to secure any types of profile (Bosch®, Item® etc.) available from the trade into V-Lock components.

Pneumatically-controlled LINEAR UNITS SERIES LEPK, featuring high precision and rigidity, long life, adjustable strokes, cushioned end stop, 2 or 3 positions.

LINEAR UNITS SERIES LEPK FOR VERTICAL MOUNTING, featuring weight balance of the slide and the applied mass.

3-JAW GRIPPERS.

ELECTRIC AXES SERIES ELEKTRO with a toothed belt, a ball circulation screw, various guide and drive systems. The figure shows an electric axis in the Elektro SHAK 340 series.

ELECTRIC AXIS FOR VERTICAL APPLICATIONS. The figure shows an electric axis in the Elektro SVAK series.

Pneumatically-controlled PRECISION ROTARY ACTUATORS. The figure shows a DAPK actuator with 2 adjustable angles.

PRECISION GRIPPERS. The figure shows a parallel long-stroke two-jaw gripper in the GPLK series.

RODLESS CYLINDERS with a V-Lock ball circulation guide.

V-Lock GUIDE UNIT for ISO 15552 pneumatic cylinders or Elektro ISO 15552 electric cylinders.

SLIDES. The figure shows an S14K compact precision slide.

R3K pneumatic ROTARY ACTUATORS, with an adjustable angle, mechanical stop or hydraulic internal or external shock-absorbers.

GRIPPERS with two parallel jaws, two hinged jaws, toggle joint and three jaws.

